

NEW ORDER

BY STEFAN DIEZ

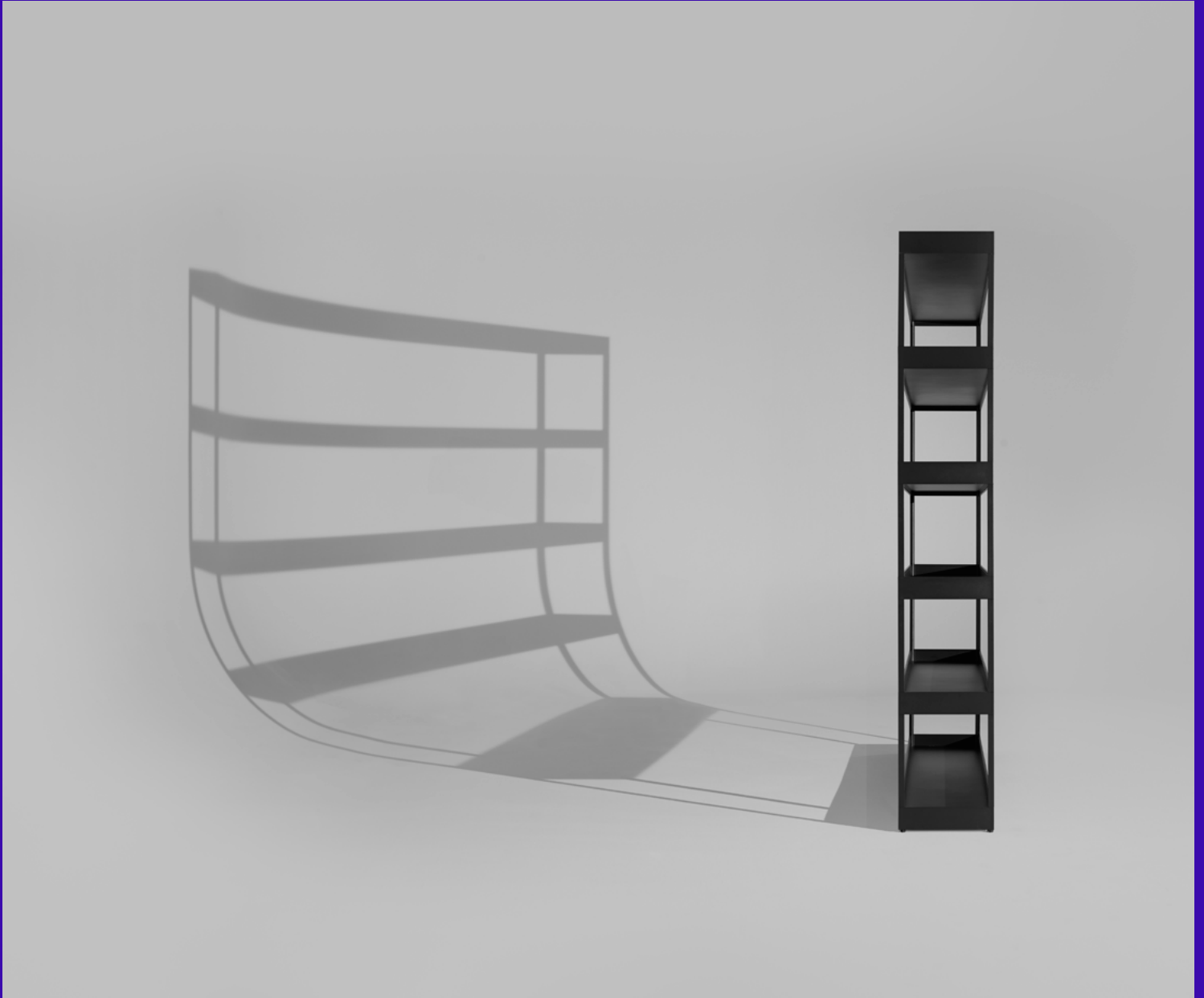

HAY

NEW ORDER BY STEFAN DIEZ

NEW ORDER

BY STEFAN DIEZ

Times are changing, and so is the way we store our life. Personal papers no longer take up several ring binders but are now neatly organized in the digital cloud alongside thousands of photos, music tracks and films. The digital age is having an impact even outside the area it has revolutionized, including the shelving systems, which used to store all these things in tidy rows. Today, the shelving unit has become more of a stage for storytelling where we exhibit personal objects and curios collected over the years. New Order matches its time by providing a shelving system that is so flexible in structure and composition that you can modify it, expand it and customize it in endless variations.

New Order is a 100% industrial choice, and we are proud of that, because this approach has led to a high-precision product in a strong modern material with exceptional properties. At first glance, the system architecture is ultra-simple, but on closer acquaintance it proves quite complex in its multi-purpose versatility. New Order can be tall or short, wide or narrow, open or closed – or any combination in between. Add to that a contemporary colour palette and uncompromising details, all of which brings added functional and aesthetic value to a ground-breaking system that is capable of adapting to keep up with the times.

New Order supports new ways of organization. Ways that are far more versatile than other shelving systems, and which speak to both your feelings and your intellect. New Order represents a vision of offering a flexible space for what you choose to collect and display throughout your life.

Mette and Rolf Hay

ARCHITECTURE

New Order is architecture that creates space.

Space for storage. Tidy and orderly space.

New Order is spatial architecture because the system organizes around the requirements of the context and is therefore both a space-dividing and space-creating system. New Order's simple grid and innovative elements that are up to 2 metres long let you build airy, open compositions or closed constructions with side panels and sliding doors.

By adding panels all around you can achieve a wall-like expression, as the closed cabinets take on visual substance and weight despite their actual lightness. As an added bonus, no amount of clutter behind the cabinet doors is going to make the slightest impression on the clean, minimalist exterior.





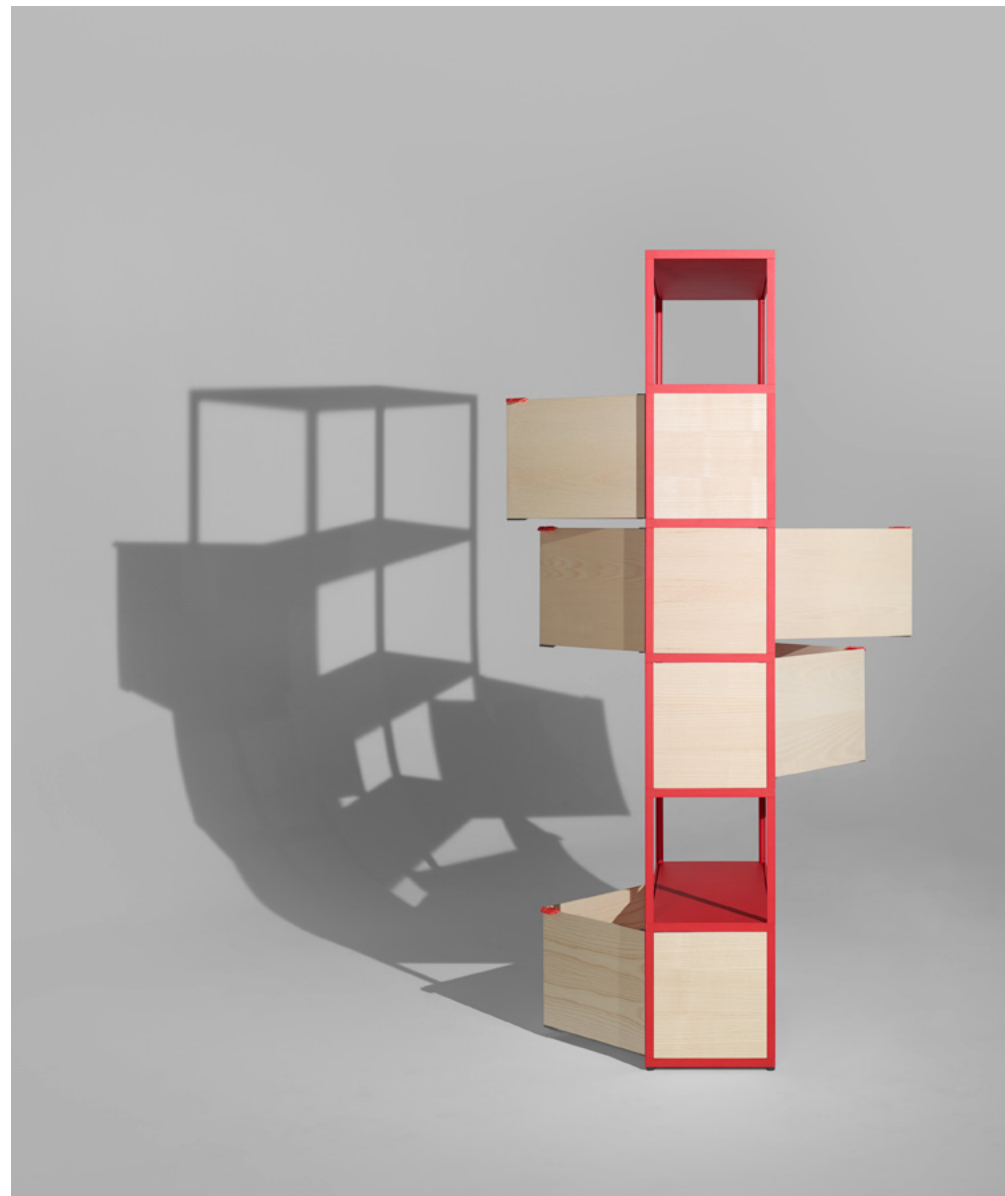

Vertical open shelf in army.

STORIES

New Order is an untraditional approach to traditional storage in a system with carefully designed functionalities. Initially, the simple, graphic grid appears almost ascetic, but gradually the system takes on substance. A tray instead of a shelf brings a homely touch – and the height of the tray gives New Order a more corporeal expression. A coloured background creates visual calm and gives the system backbone. Add side panels, and the unit gradually closes up. Click a sliding door into place, and you have a full-fledged functional storage solution.

“New Order sets new standards for shelving systems because the industrial manufacturing process has been incorporated into the product design from the outset. The functionality is exceptional, with doors that can be clicked on and off without the use of tools; and the aesthetic experience is equally convincing.”

/ Rolf Hay



Low side cabinet with top tray in light grey with stained light grey ash panels.

"New Order is open space in sections that are up to two meters long – a length that no other shelving units can match, because wood cannot support the weight of books in such a long span. This is new and strong and will help New Order to go far."

/ Rolf Hay

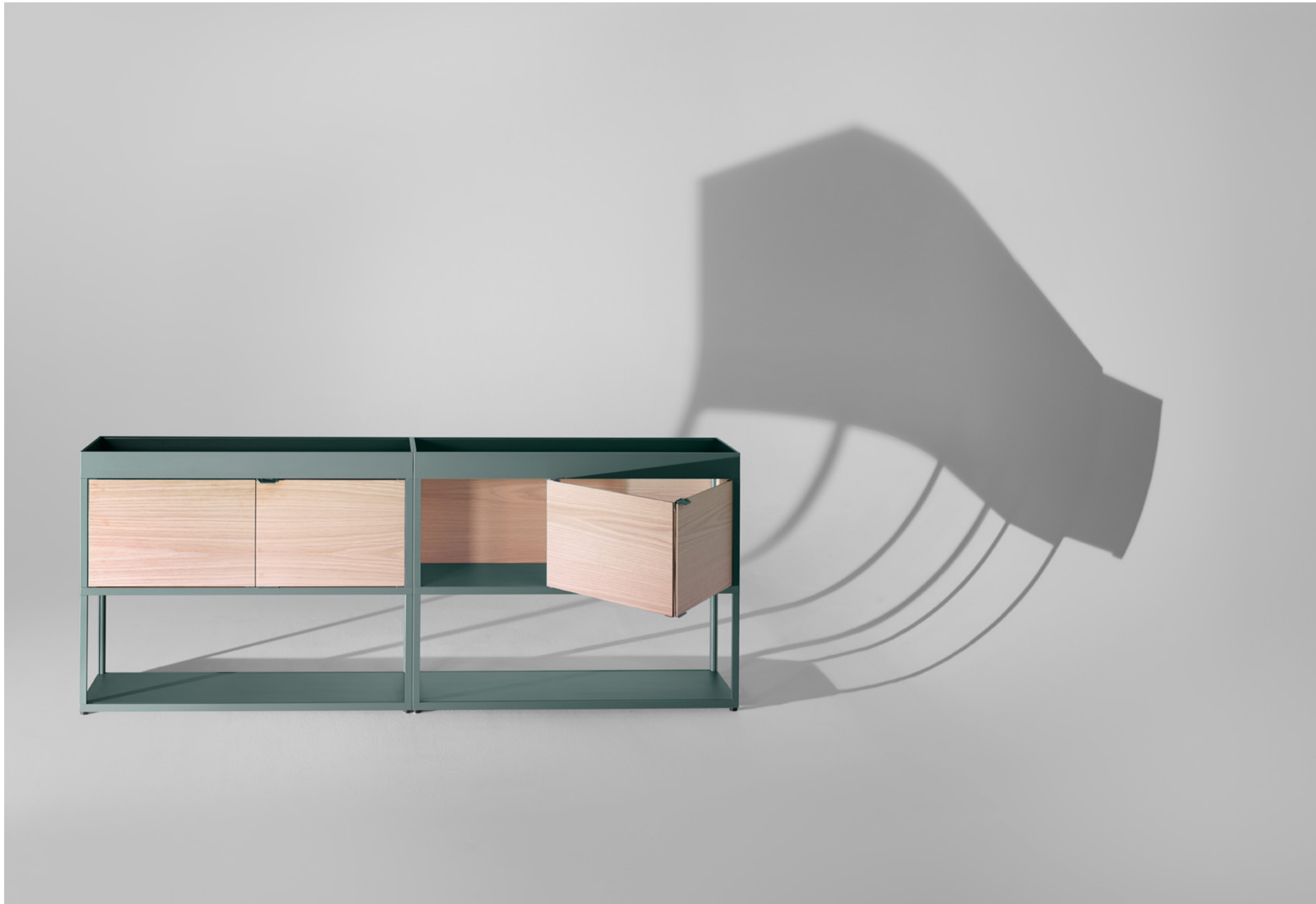



"Things are increasingly important to us because they recall the different details in our life."
/ Stefan Diez





"New Order is like an alphabet, where you can create new words, sentences and meaning in different accents."

/ Stefan Diez

COLOURS

New Order features a modern handful of classic and contemporary colours that underscore the capacity of the system to go all the way to offer a unique and personal solution. Black, light grey and army are the classic colour codes, while yellow, red and chocolate are the new signal colours that let New Order rise above our conventional expectations for shelving systems. Add to that the possibility of combining this colour selection with natural ash or oak, stained black or light grey ash – and New Order climbs to the top of your personal and professional wish list.





"We have created a signature with various characters breathing the same air within the same family spirit. New Order is received as furniture, even though it is a system."

/ Stefan Diez



WALL-MOUNTED

New Order can also be mounted on the wall, offering both functional storage and a visual renewal of interior space. Establish alternative formations by constructing new structures in colour sections, perhaps in combination with wooden panels and doors to create unique storage architecture. Build horizontally and vertically. Design open or closed spaces. Make room to store your life in new ways in new constructions and colour combinations.

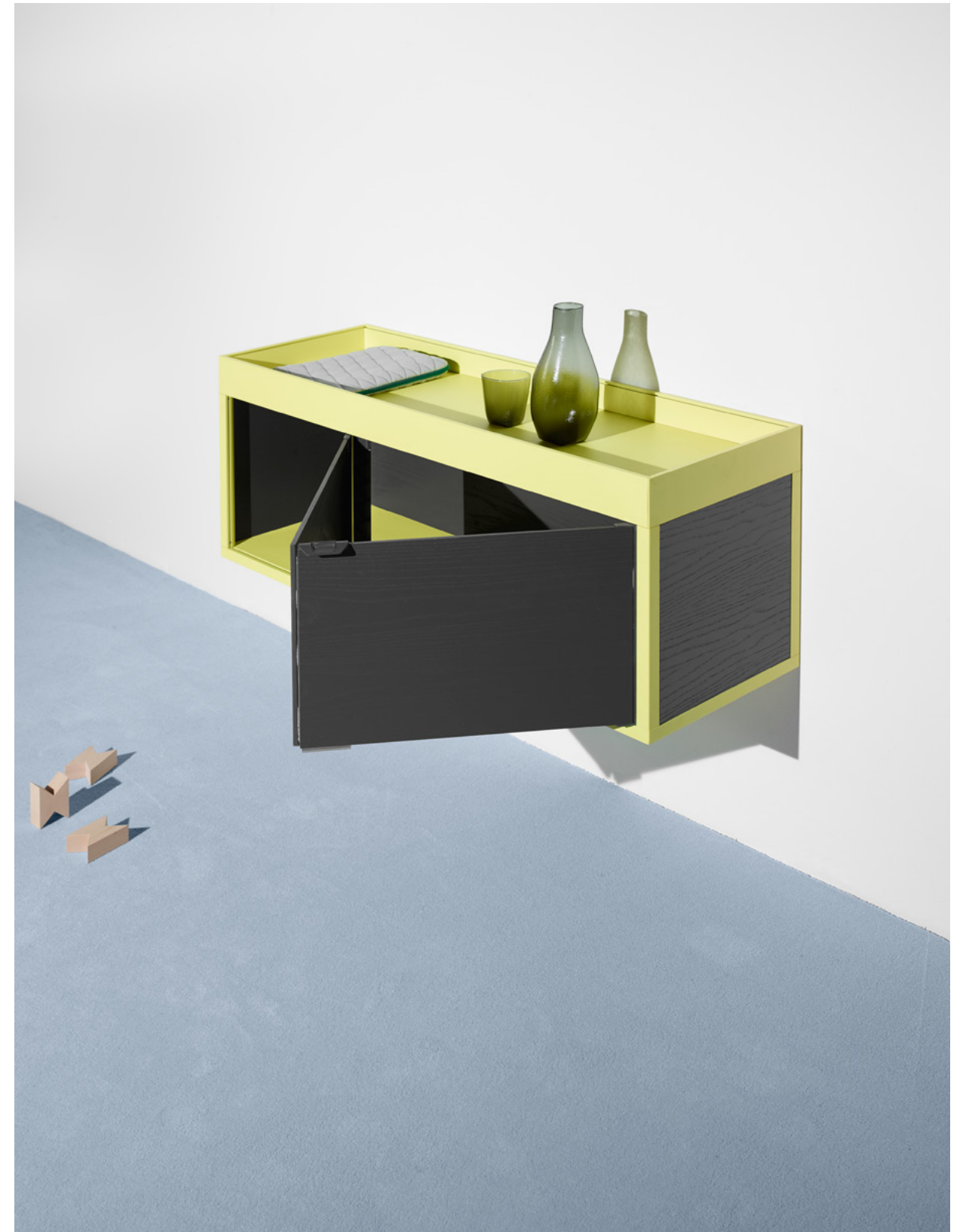

Wall-mounted cabinet in yellow with sliding door in stained black ash.



HINGES and DOORS

New Order is born of industrial production. This reflects HAY's core ambition of creating uncompromising quality products. The hinges are high-precision design engineering, and physically and visually they are so light that you barely notice them. They just do their job. The hinges are designed to be clicked into place without the use of tools, just as the panels simply slide in, and the door is easy to fold. New Order is the flexible lightness of storage in a durable form.

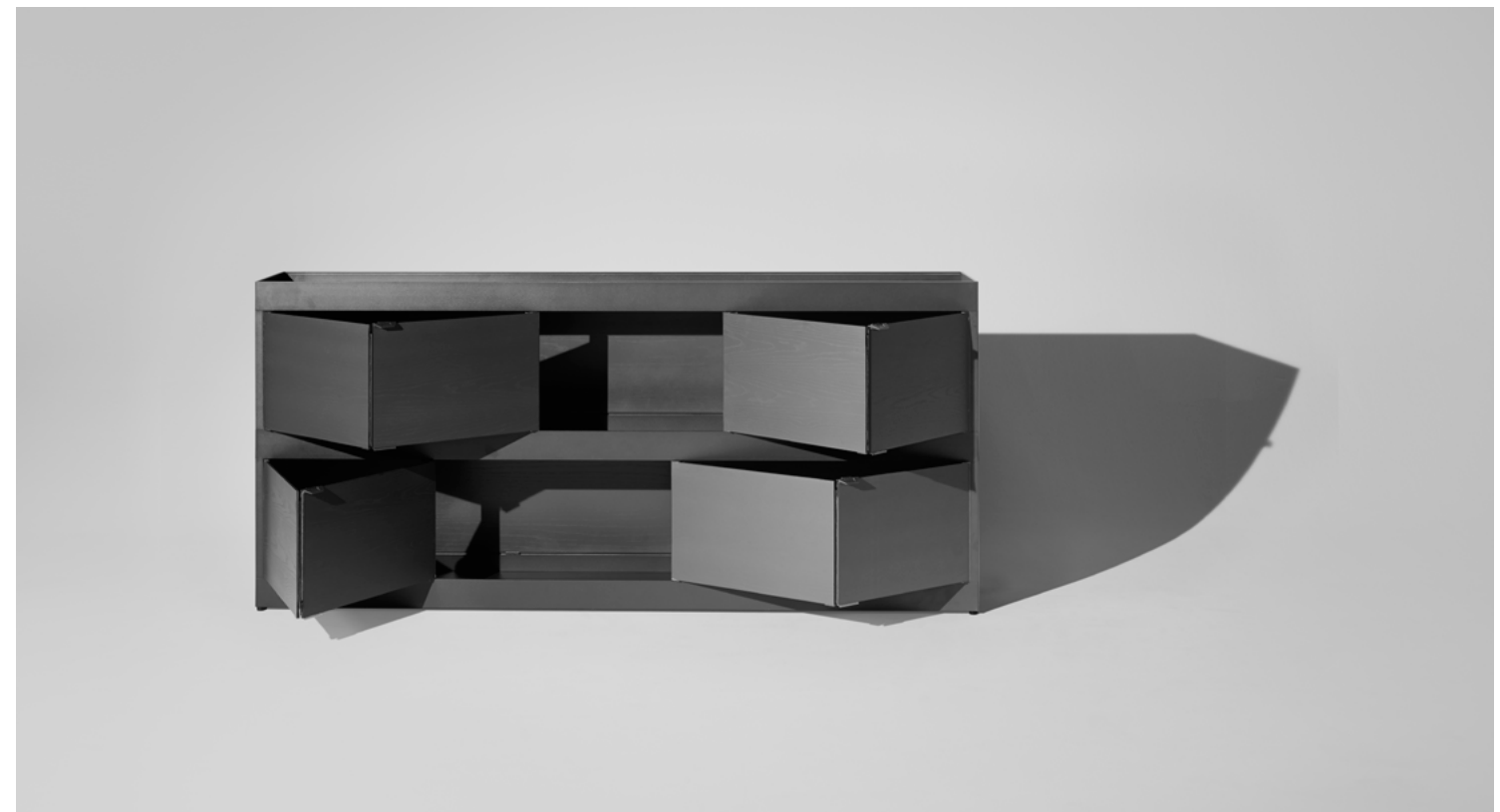



Assembling prototypes at Stefan Diez Office.

CORNER MODULE

New Order's corner module combines practical and aesthetic qualities in a single design solution. The corner module lets you slip the shelving system around a corner or design your own closed formations or a semi-closed room in a room. The square corner module offers the same features as the other components in the system including the option of closing sections off with doors, back panels and side panels or building an open transparent column for visual display, as the tray function is also available in the square format of the corner module.



Use the corner module to build individual landscapes.



Reviewing early prototypes at Stefan Diez Office.

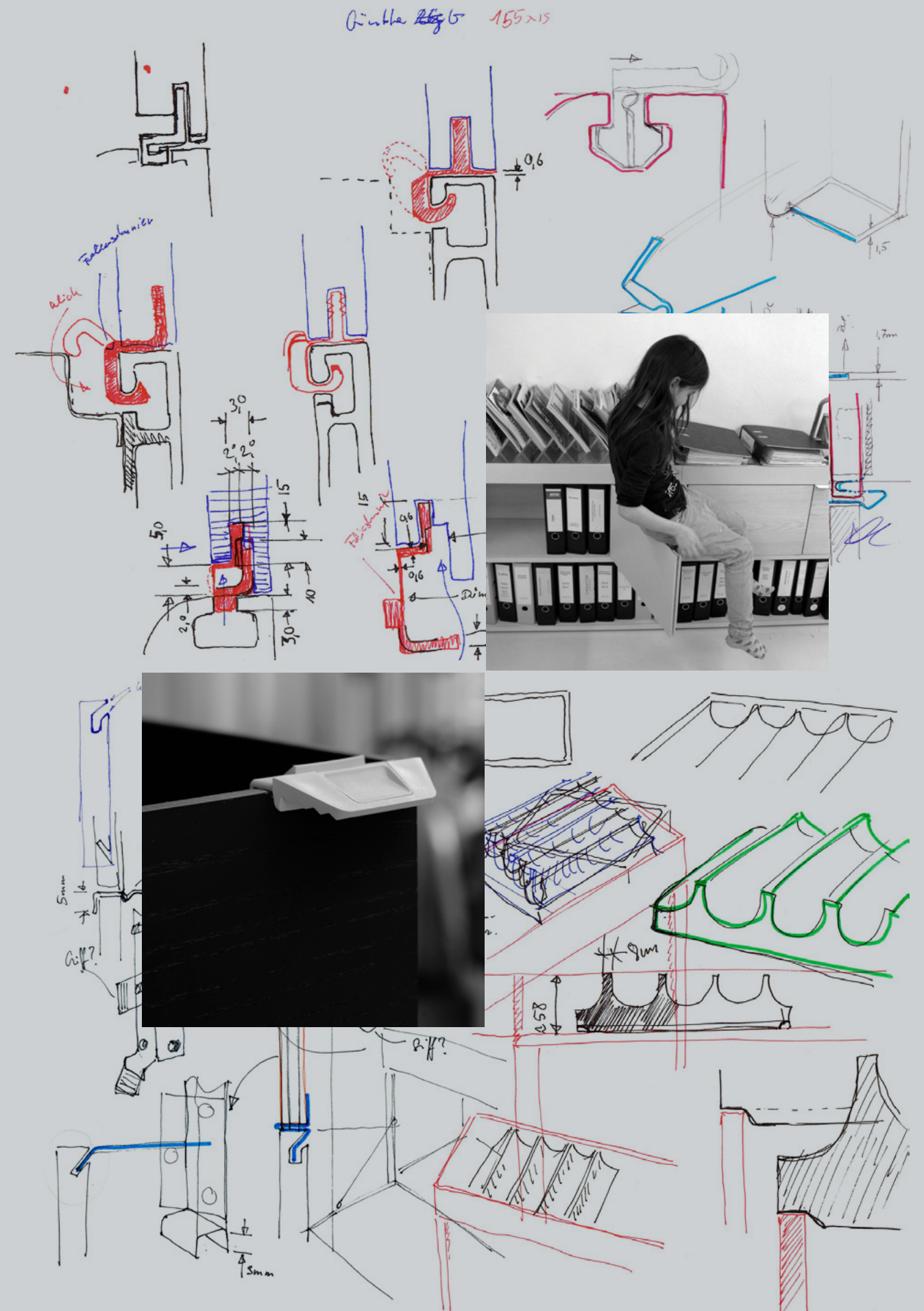

Side tables

L100 X W34 X H38,5 cm
 L100 X W34 X H44,5 cm
 L100 X W34 X H50 cm

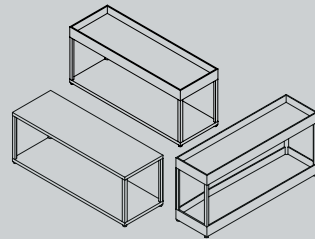
**Wall-mounted cabinet with top tray**

L100 X W34 X H43,5 cm

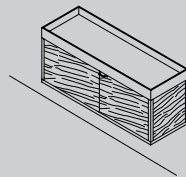
**Open sideboard with top tray**

L100 X W34 X H79,5 cm

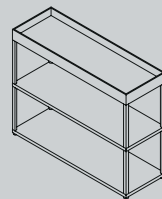
**Open wall-mounted shelf**

L100 X W34 X H109,5 cm

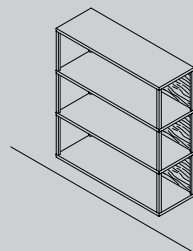
**Horizontal wall-mounted sideboard**

L300 X W34 X H37,5 cm

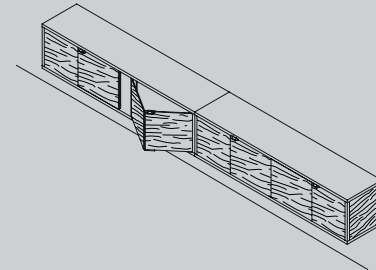
**Double sideboard with top tray**

L200 X W34 X H79,5 cm

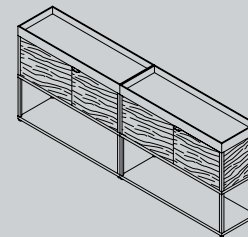
**Horizontal cabinet**

L400 X W34 X H44,5 cm

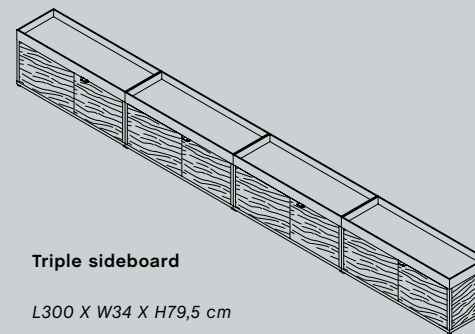
**Triple sideboard**

L300 X W34 X H79,5 cm

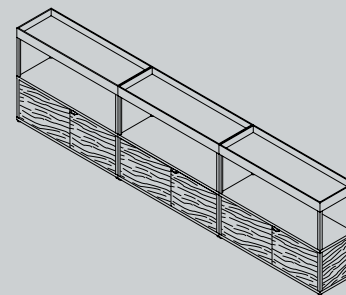
**Sideboard with top tray**

L200 X W34 X H91 cm

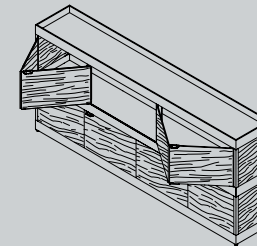
**Vertical shelf**

L100 X W34 X H215 cm

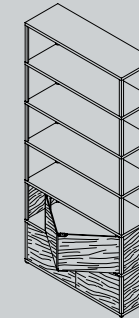
**Corner cabinet**

L234 X W134 X H74 cm

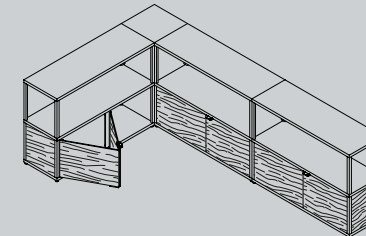
**Vertical open shelf**

L150 X W34 X H180 cm

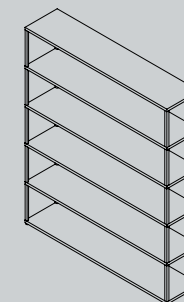
**Horizontal open shelf**

L300 X W34 X H110 cm

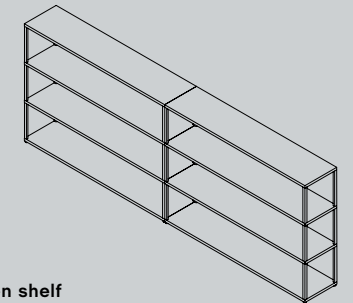
**Vertical open shelf with trays**

L200 X W34 X H214 cm

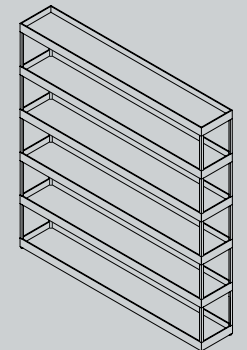
**Irregular open shelf with trays**

L300 X W34 X H173 cm

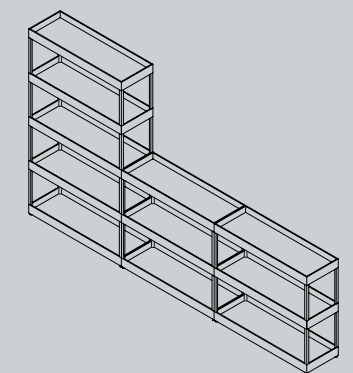

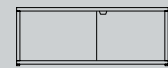

L100 X H38,5 cm



L100 X H50 cm

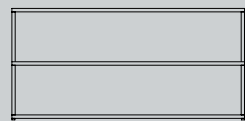

L150 X H74 cm

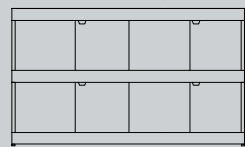

L150 X H91 cm



L200 X H79,5 cm



L300 X H79,5 cm

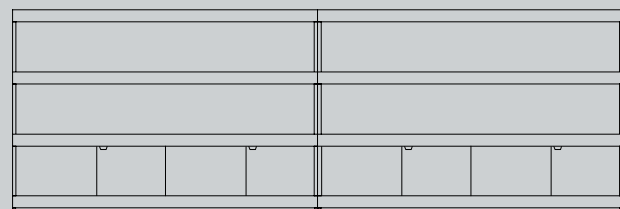

L400 X H132 cm

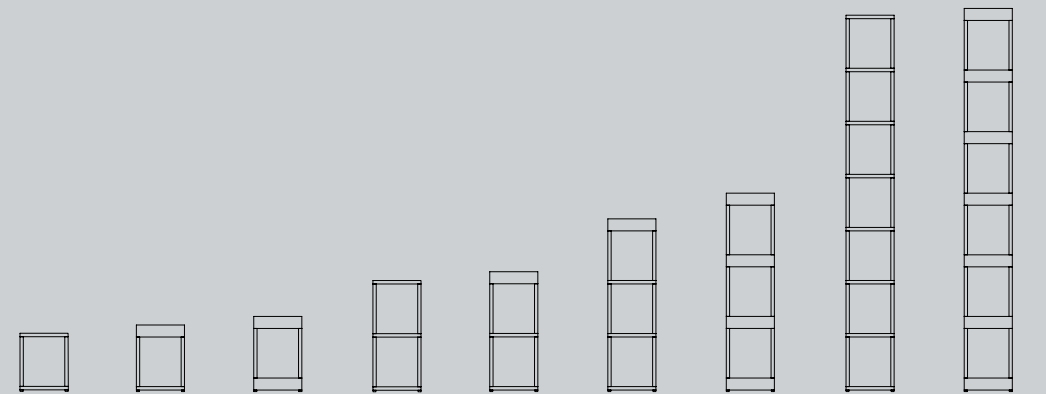
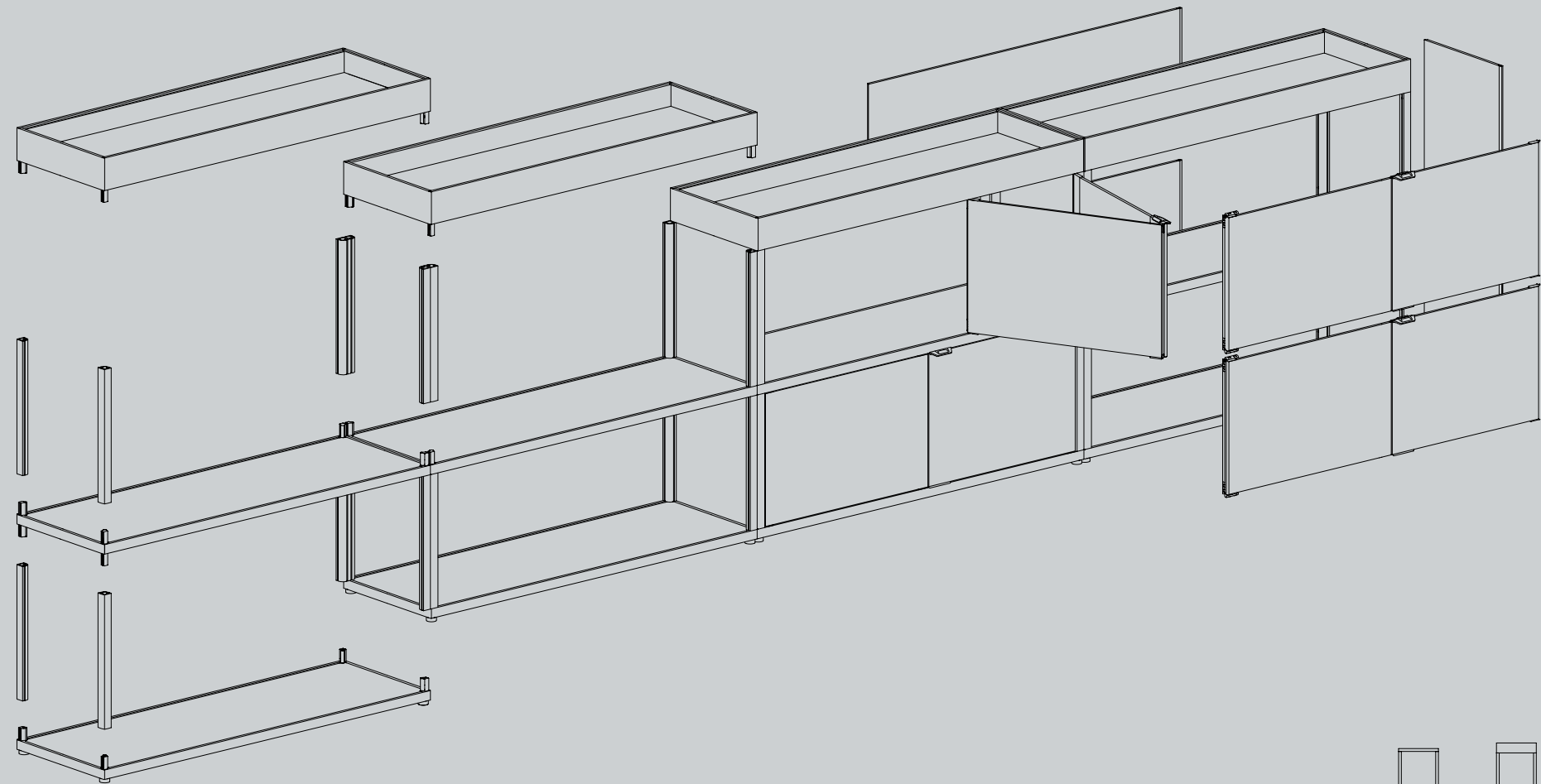

H38,5 cm H44,5 cm H50 cm H74 cm H79,5 cm H115 cm H132 cm H250 cm H255 cm

Trays

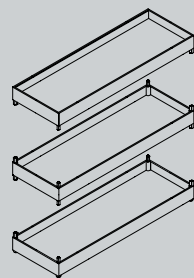

Tray, corner top, middle and bottom
W34 X H8 cm



Tray, top, middle and bottom
W100 X H8 cm



Tray, top, middle and bottom
W150 X H8 cm

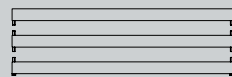

Tray, top, middle and bottom
W200 X H8 cm



Panels

Set of 2 side panels + 1 back panel

Side panel (X2)
L28 X H33 cm



Back panel 100
L95 X H33 cm

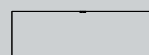

Back panel 150
L145 X H33 cm

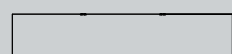

Back panel 200
L195 X H33 cm



Sliding doors

Sliding door for 100 cm



Sliding corner door for 100 cm



Sliding door for 150 cm



Sliding door for 200 cm



Shelves

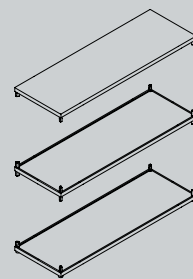

Shelf, corner top, middle and bottom
W34 X H23 cm



Shelf, corner top, middle and bottom
W100 X H23 cm

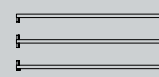

Shelf, corner top, middle and bottom
W150 X H23 cm

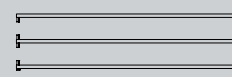

Profiles

Single profile set (X4) H33 cm



Double profile connector set (X2) H33 cm



Corner profile connector set (X1+1 single profile) H33 cm



Wall brackets / Wall panels

Wall bracket set (X2) L6 X H33 cm



Wall panel 100 L95 X H33 cm

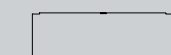

Wall panel 150 L145 X H33 cm



Wall panel 200 L195 X H33 cm

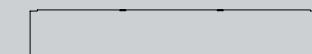

Frame, powder coated aluminium

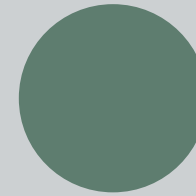

Army

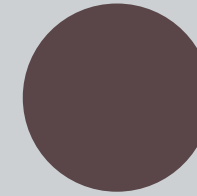

Chocolate



Light grey



Yellow

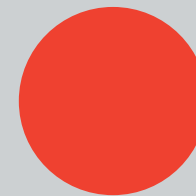

Red

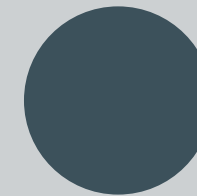

Charcoal

Panels and sliding doors, veneer

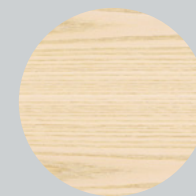

Ash



Oak



Stained black ash



Stained light grey ash



Copyright / Nine United Denmark A/S 2014
Main photos / Rasmus Norlander
Additional photo / Stefan Diez Office
Art Direction / Clara von Zweigbergk and Shane Schneck
Graphic Design / Clara von Zweigbergk
Text / Charlotte Jul
Subject to printer's errors
www.hay.dk

HAY